

Small Elf House

Assembly instruction

Vector Painter

© Ivan Bilous

ivan.bilous95@gmail.com

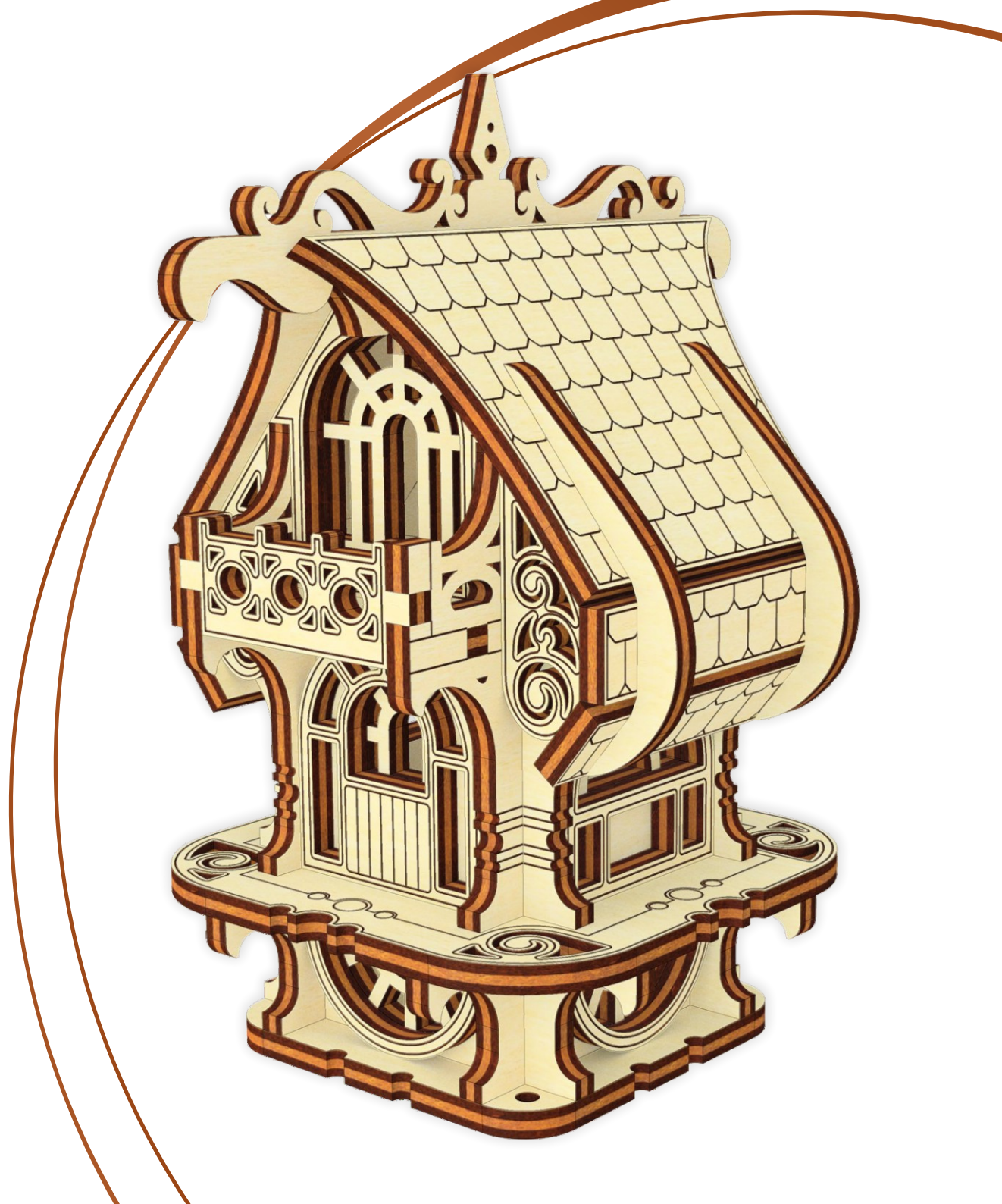

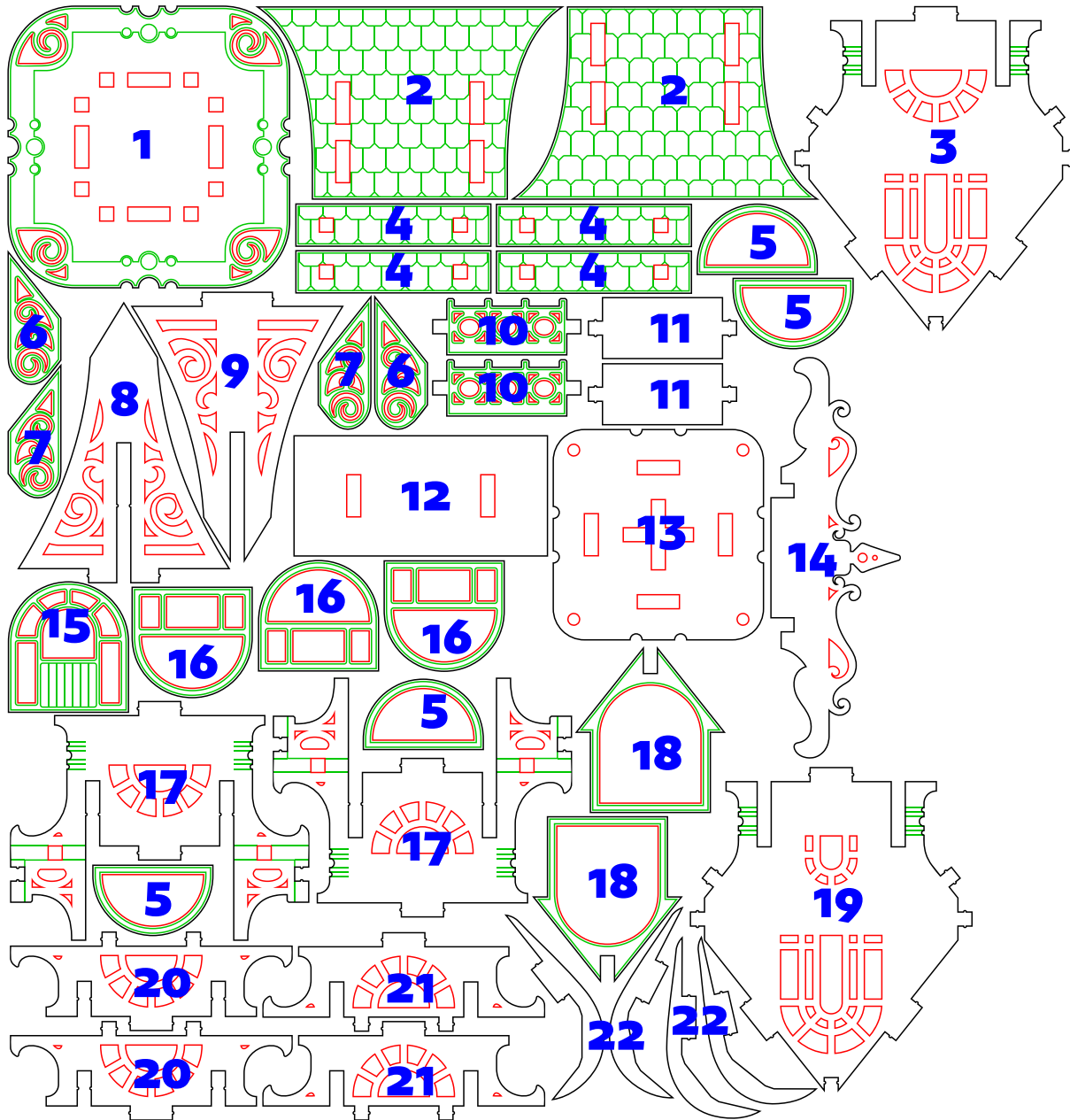

Thanks for your order! Please remember the policy of using my designs

YOU CAN use the files for personal purposes
YOU CAN use up to 30 copies for commercial purposes.

For larger production contact me.

Also You should indicate my authorship "© Ivan Bilous" for commercial use,

YOU CANNOT share, redistribute or resell the files. **YOU CANNOT** use my pictures.

Copyright is not transferable with the sale.

green color - SCORE (cut with low power and high speed)
red color - CUT (inner cut lines)
black color - CUT (outer cut lines)

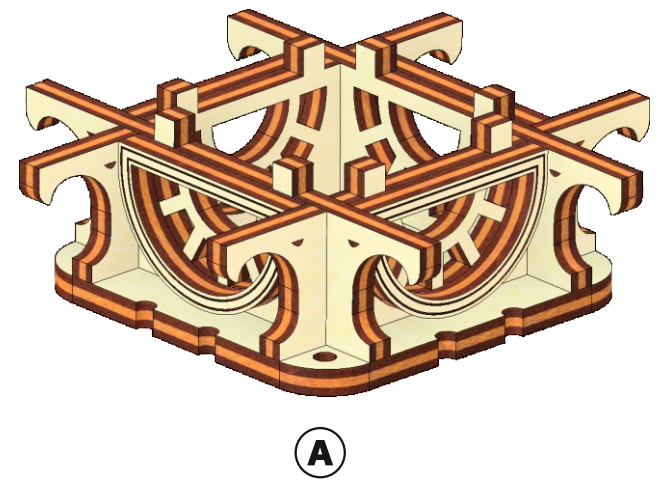
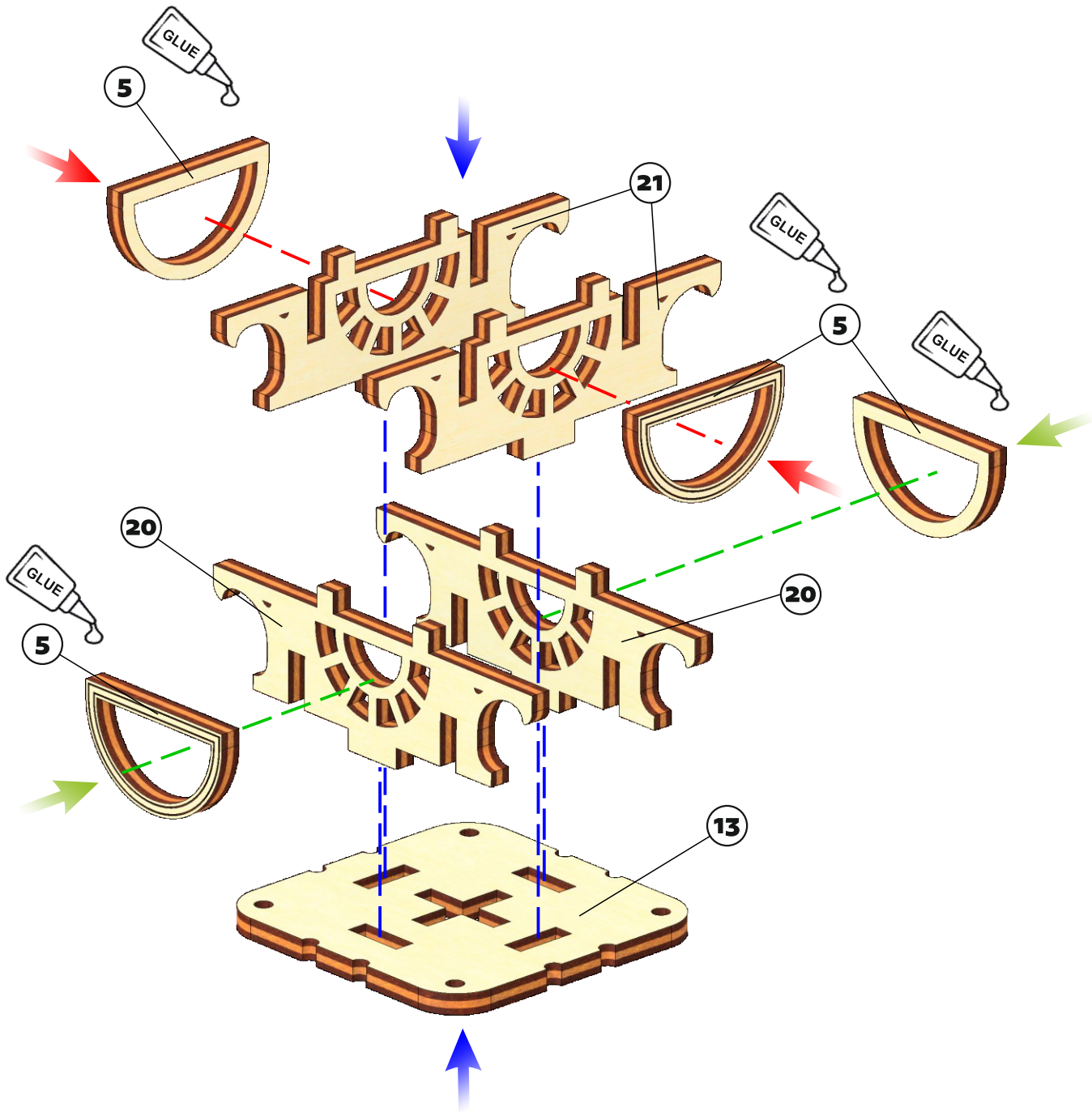

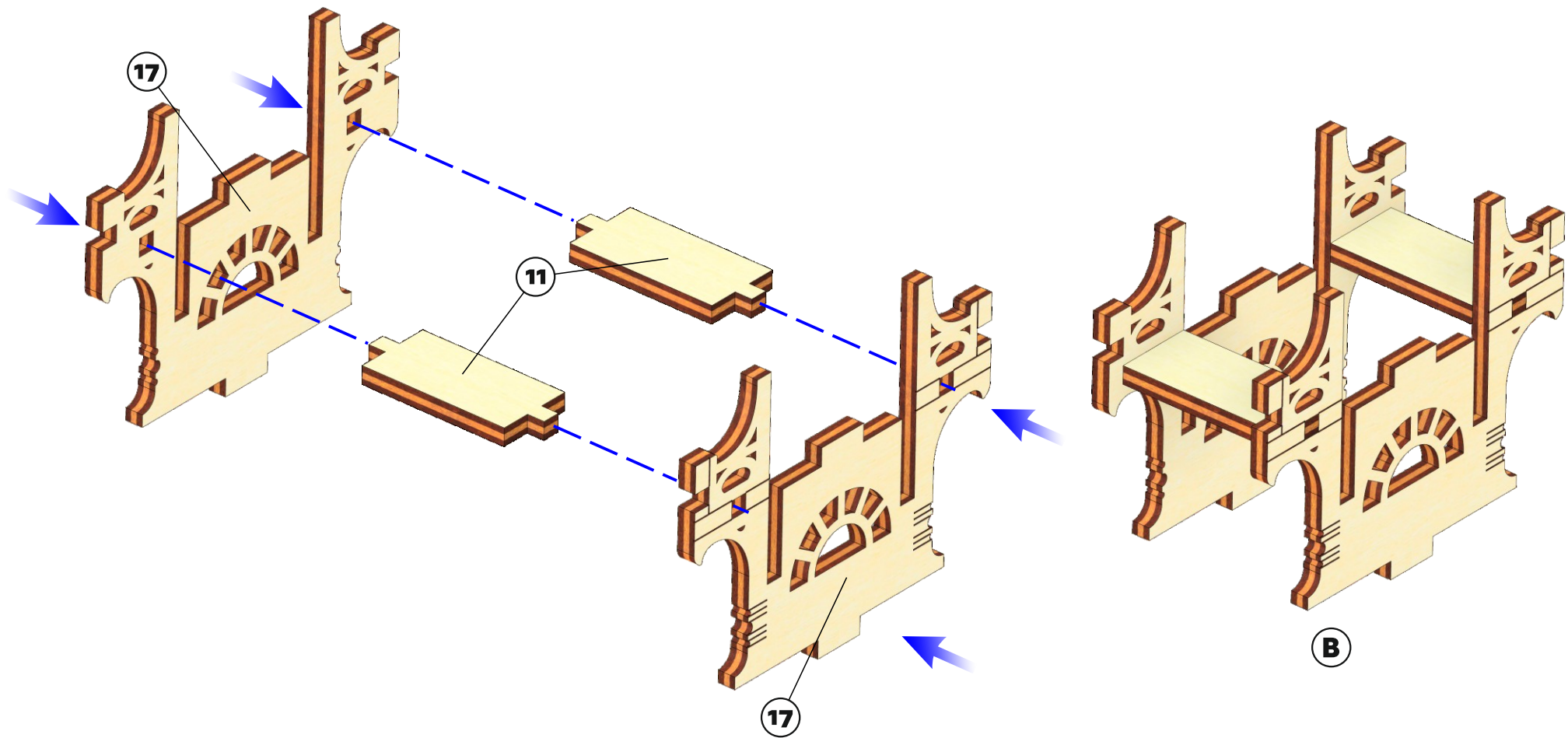

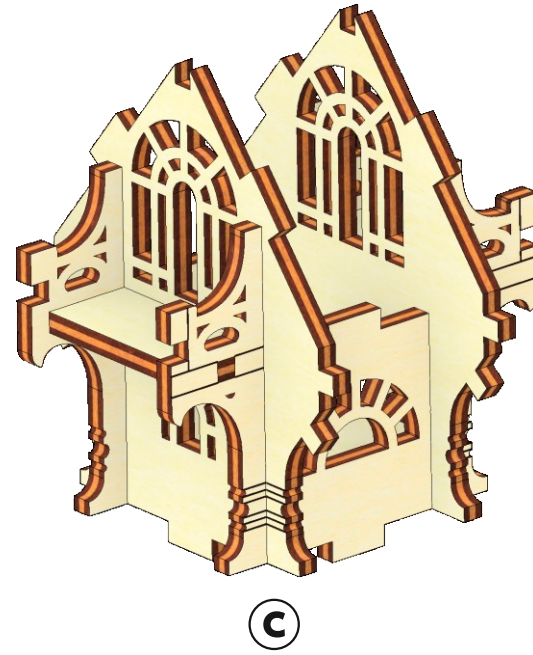
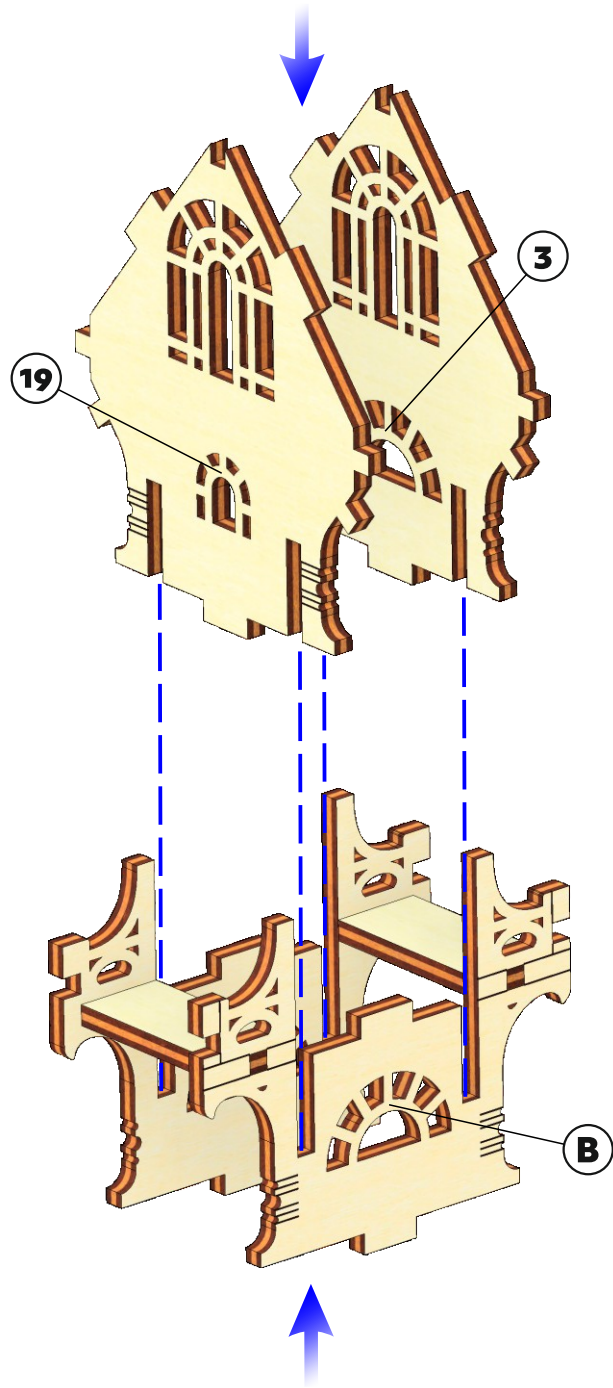

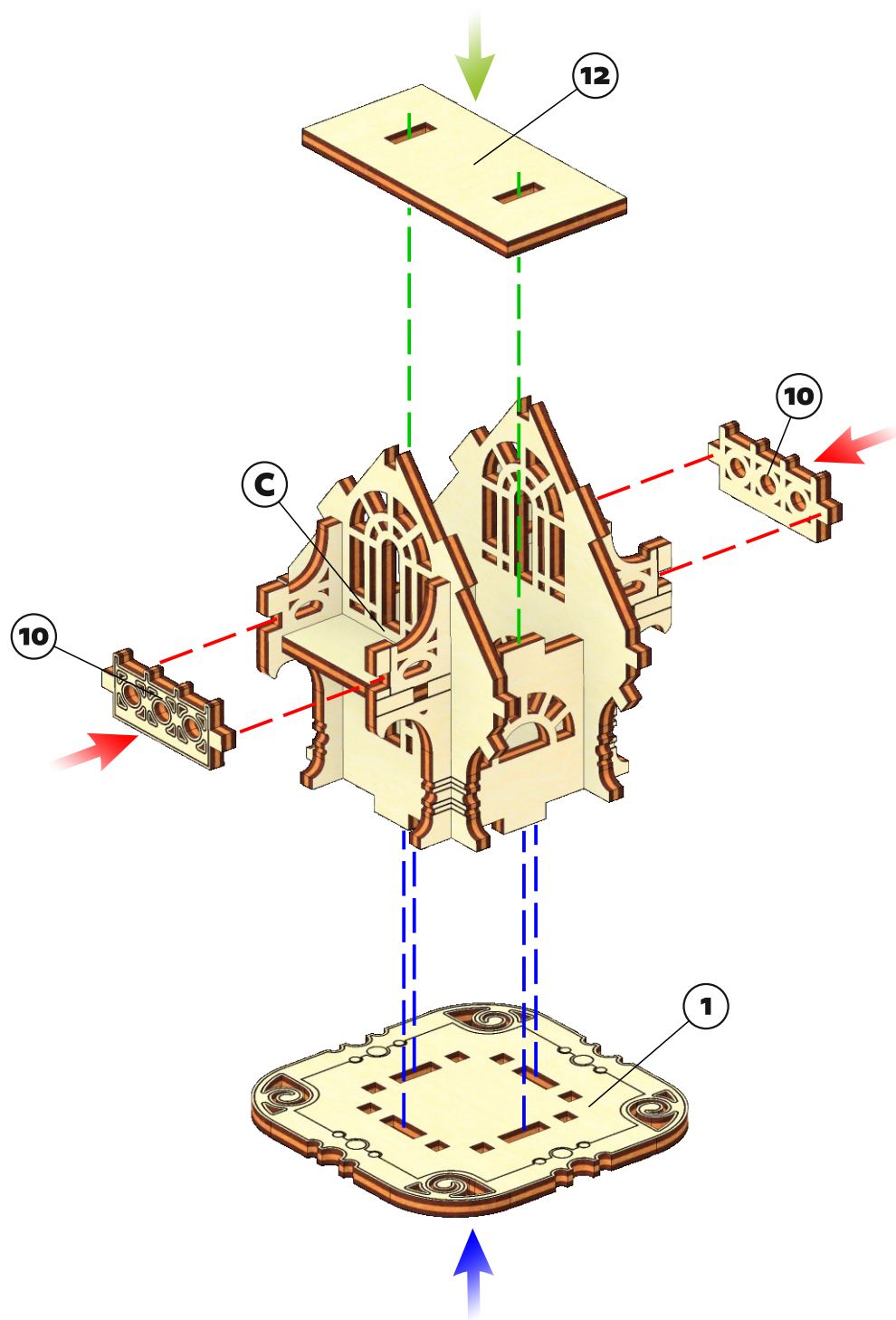

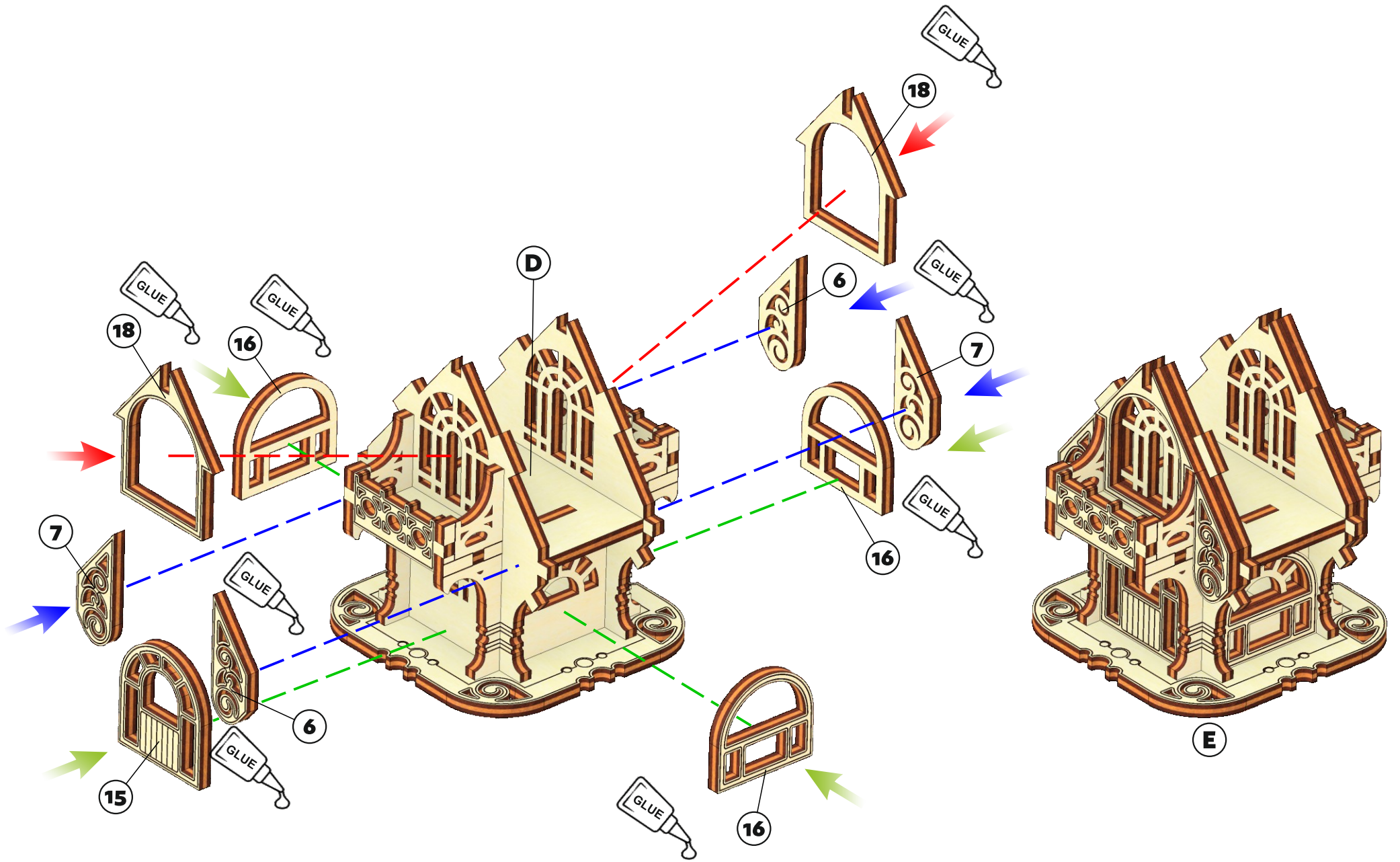

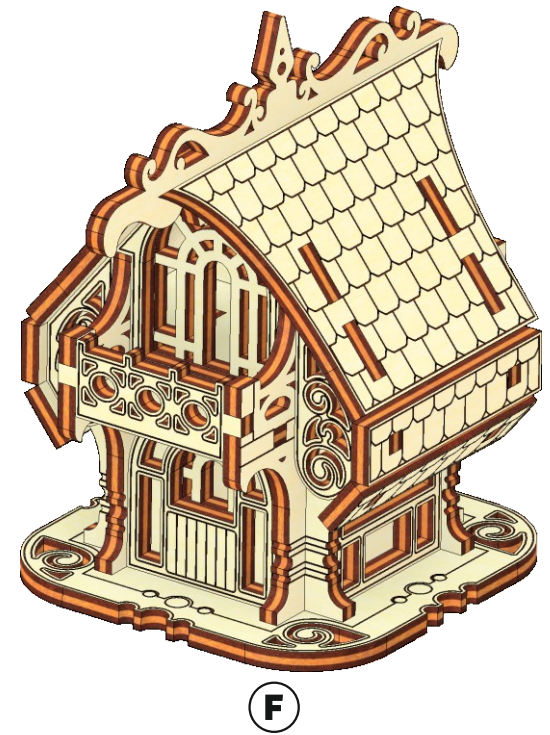
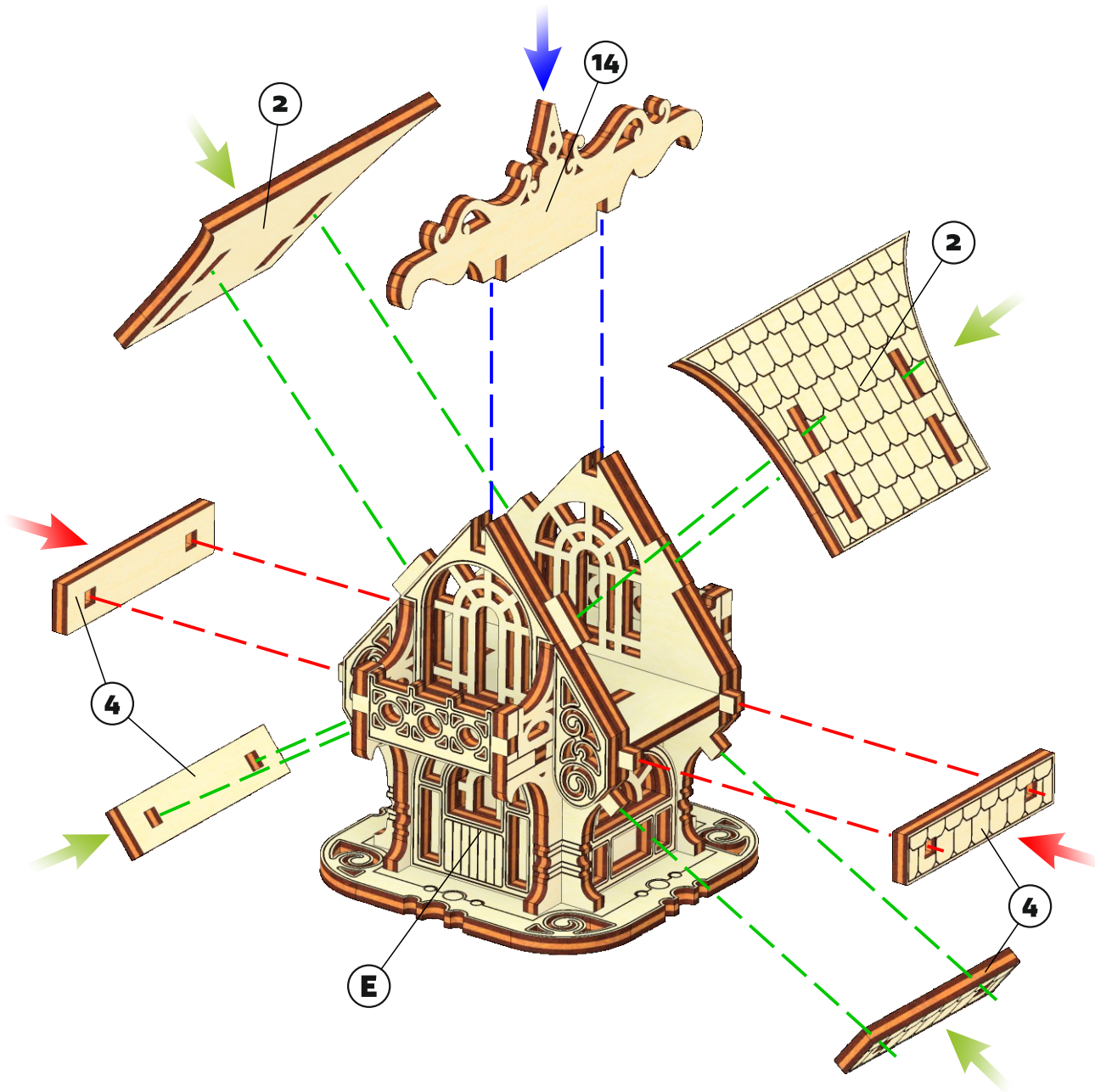

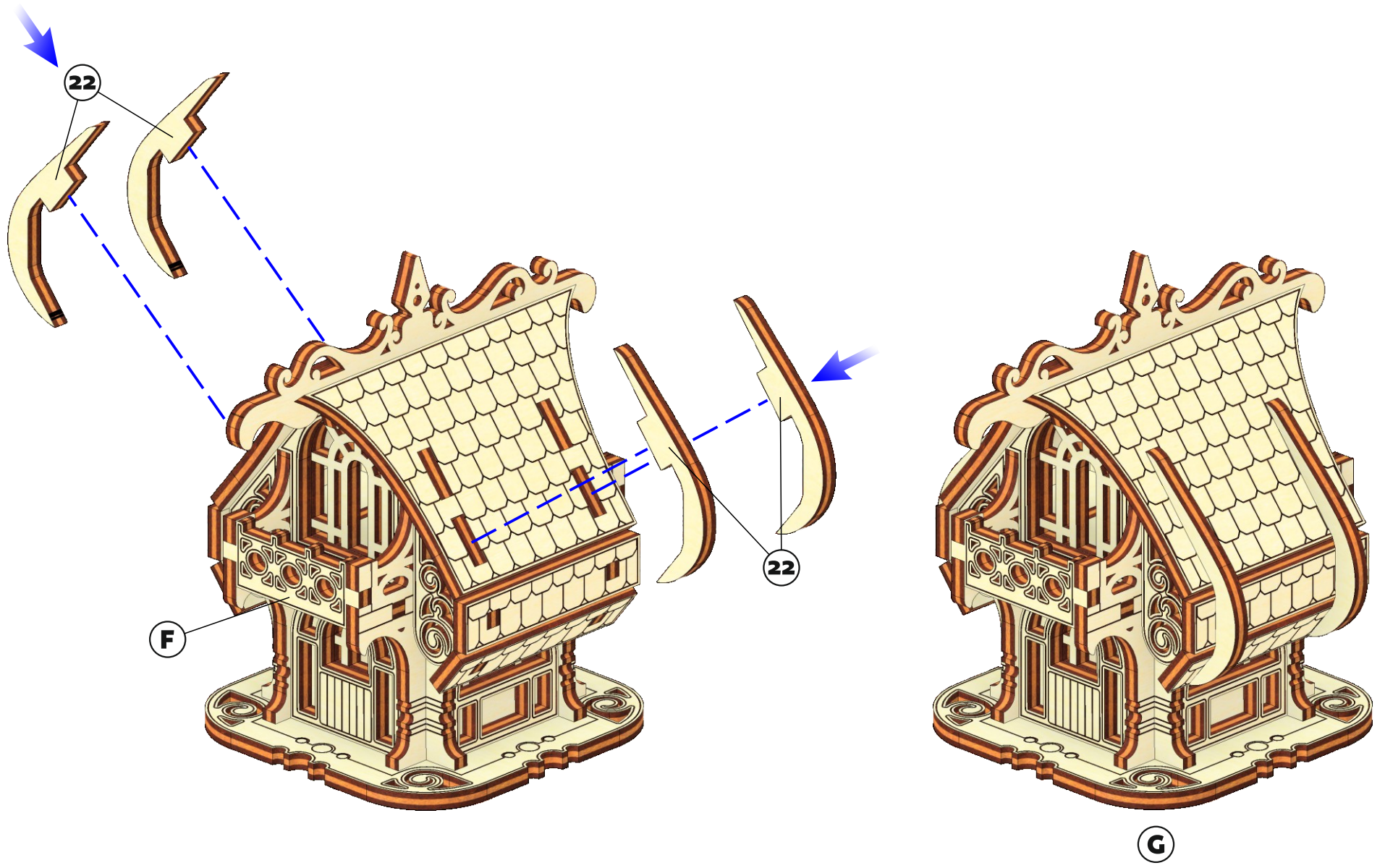

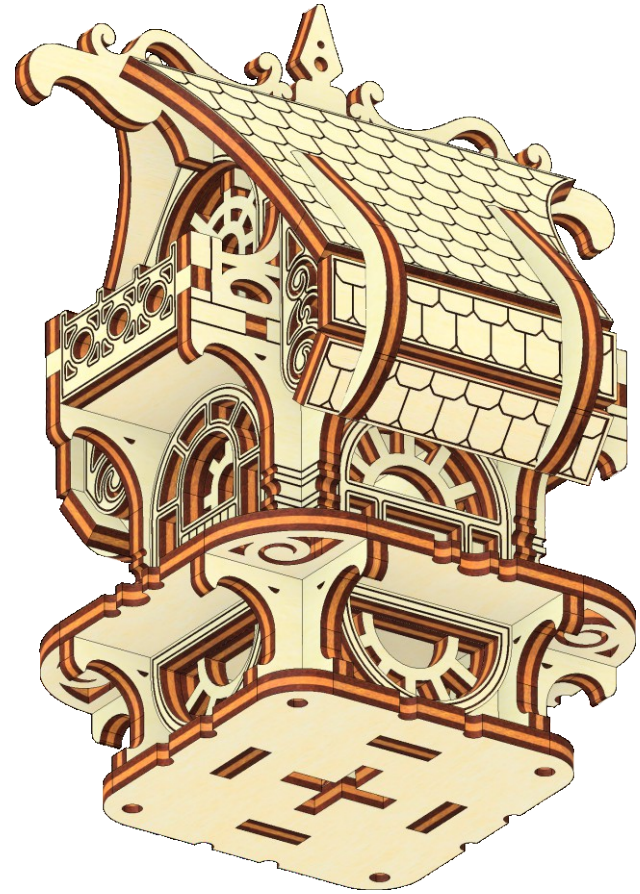
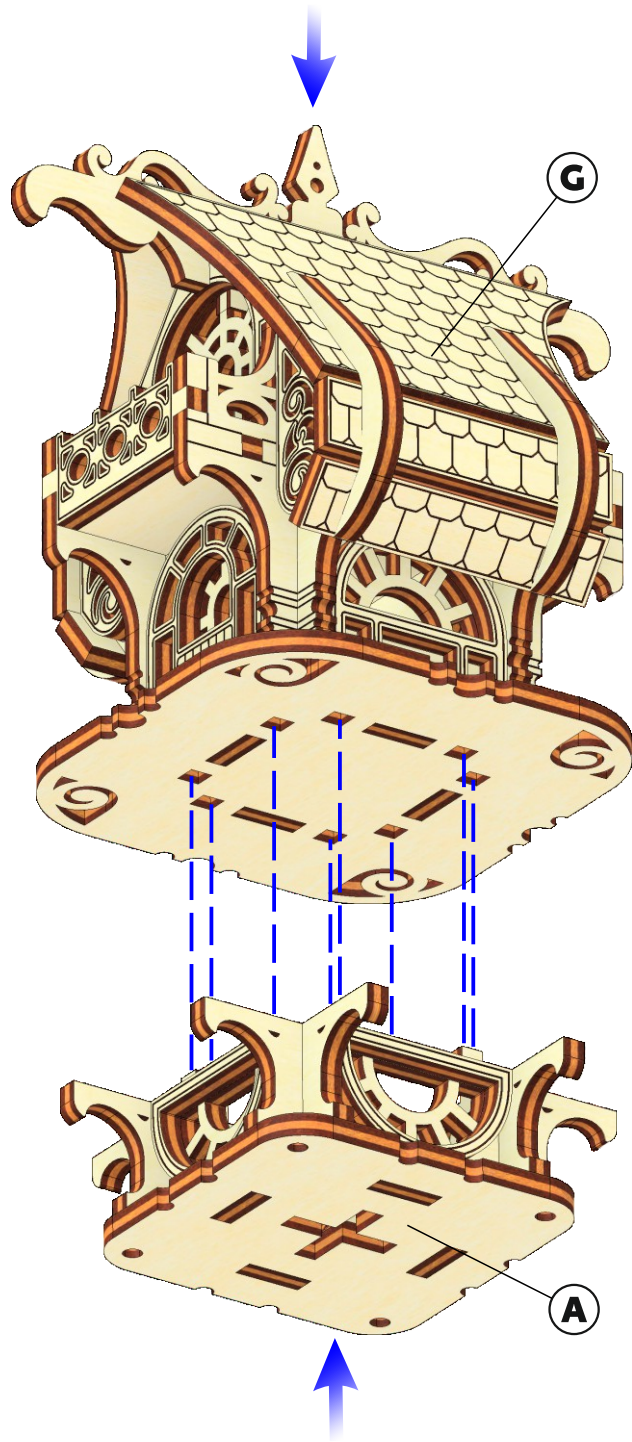

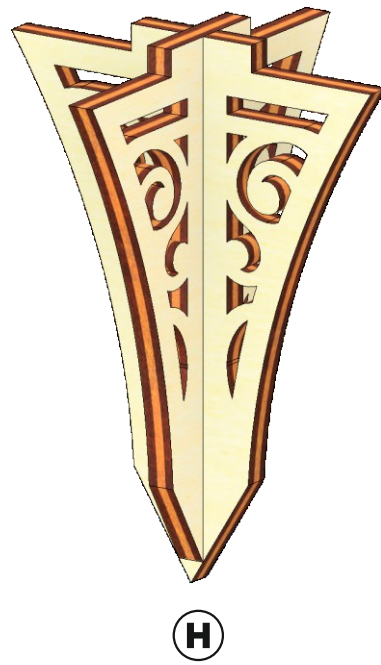
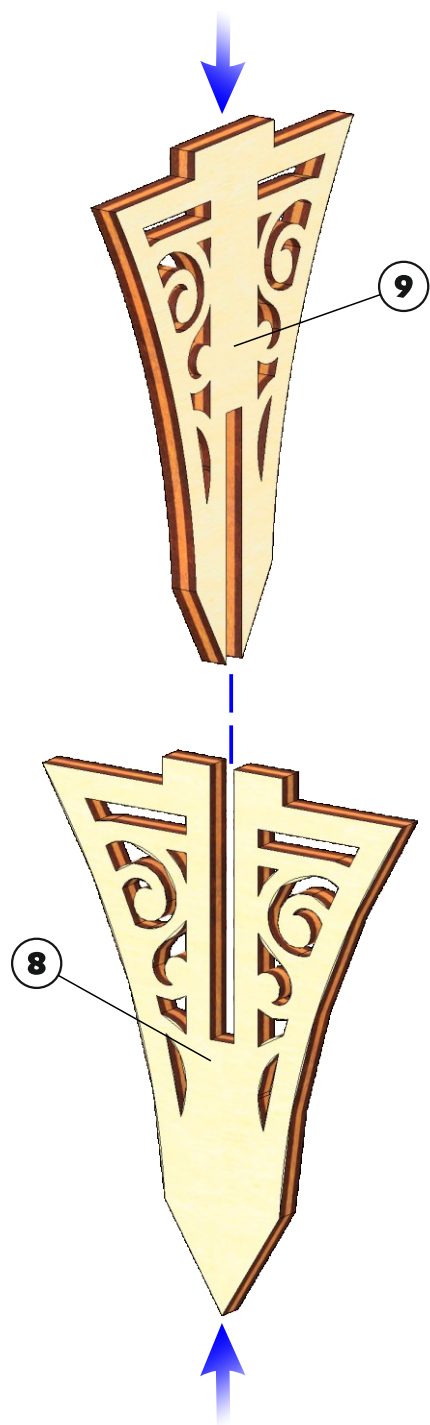

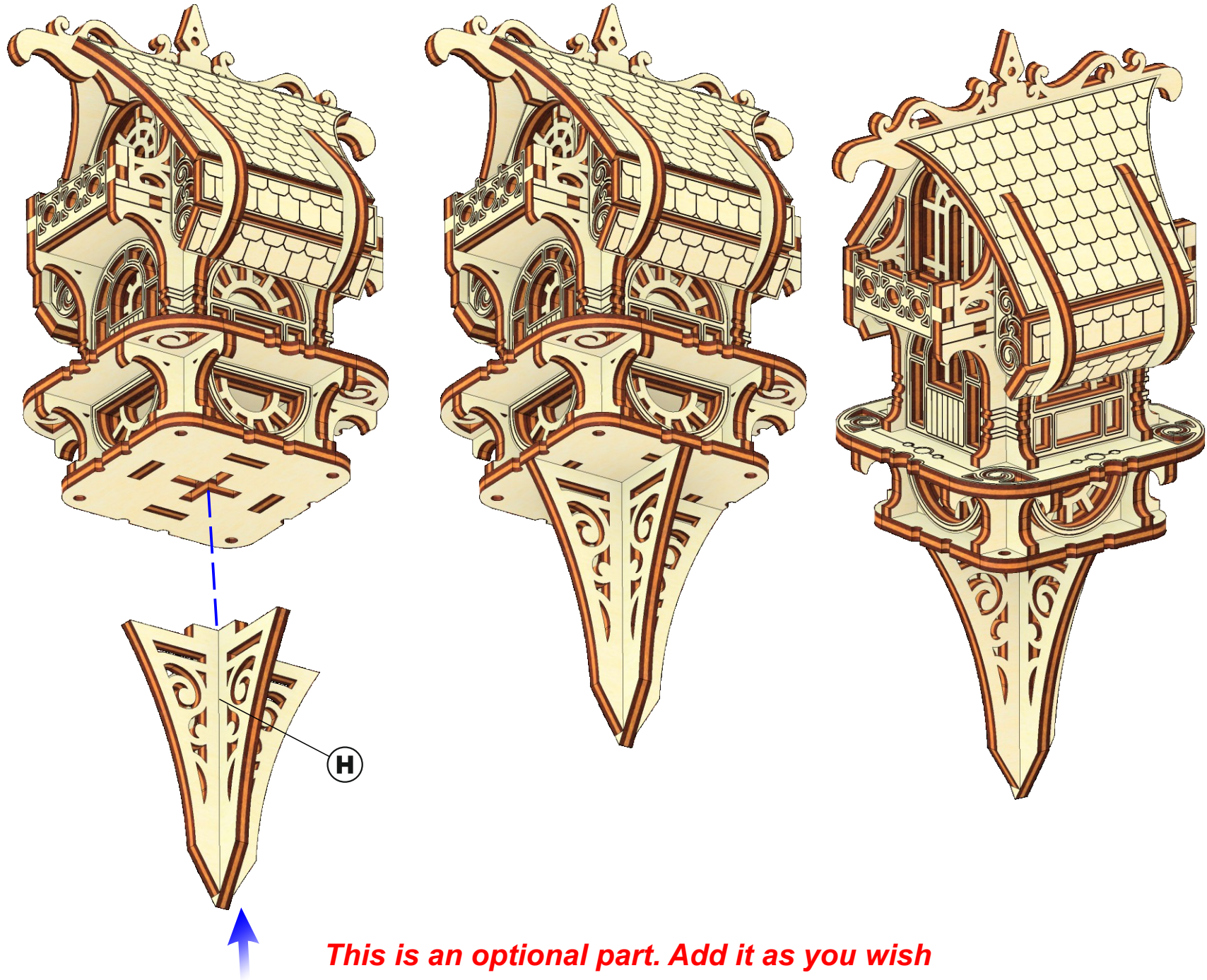

This is an optional part. Add it as you wish

Thank you! I hope you liked the file!



I would like to tell you a bit of info that can be useful for you.

1) First I want you to know that feel free to contact me if you have any questions or problems with my file. My main goal is quality service and a satisfied customer. Adjustments, changes of material thickness or just laser cutting advice. I'll be happy to help you.

My contacts:

ivan.bilous95@gmail.com



2) **WHOLESALE PRICES** work in my store

Use promocodes for discount

3 files - **WHOLESALE3** - 15%

5 files - **WHOLESALE5** - 20%

10 files - **WHOLESALE10** - 30%

VECTOR PAINTER
web-store

3) I also have my own e-store

<https://www.vector-painter.com/>

You will find the same files here as in the Etsy store, but at discounted prices, since I do not have to pay additional fees for the marketplace. For residents from Europe, the price will be on average 20% less. Wholesale promocodes also work here.



PATREON

4) For those who often make purchases of laser files, it will be beneficial to subscribe to my Patreon page.

<https://www.patreon.com/vectorpainter>

Patreon is a site for independent artists like me. I get a small subscription fee from my subscribers, and in return I give them access to my content, in my case some laser files. It turns out something like one designer who works for many people. I hope that it will be beneficial for everybody. This is all from \$ 2, \$ 5 or \$ 10 monthly by choice.



5) You can also follow me in social networks

<http://www.facebook.com/Vector-Painter-103409864677133>

<https://www.instagram.com/vectorpainter/>

https://www.pinterest.com/plywood_toys/



I'll be really happy if you leave positive feedback:)

Best regards,

Ivan Bilous

owner & designer VectorPainter store - files for laser cutting